



STW6NB100

N - CHANNEL 1000V - 2.3Ω - 5.4A - TO-247 PowerMESH™ MOSFET

TYPE	V _{DSS}	R _{DS(on)}	I _D
STW6NB100	1000 V	< 2.8 Ω	5.4 A

- TYPICAL R_{DS(on)} = 2.3 Ω
- EXTREMELY HIGH dv/dt CAPABILITY
- ± 30V GATE TO SOURCE VOLTAGE RATING
- 100% AVALANCHE TESTED
- VERY LOW INTRINSIC CAPACITANCES
- GATE CHARGE MINIMIZED

DESCRIPTION

Using the latest high voltage technology, STMicroelectronics has designed an advanced family of power Mosfets with outstanding performances. The new patent pending strip layout coupled with the Company's proprietary edge termination structure, gives the lowest R_{DS(on)} per area, exceptional avalanche and dv/dt capabilities and unrivalled gate charge and switching characteristics.

APPLICATIONS

- HIGH CURRENT, HIGH SPEED SWITCHING
- SWITCH MODE POWER SUPPLIES (SMPS)
- DC-AC CONVERTERS FOR WELDING EQUIPMENT AND UNINTERRUPTIBLE POWER SUPPLIES AND MOTOR DRIVE

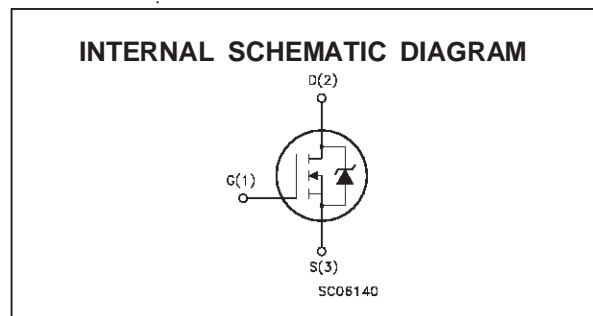
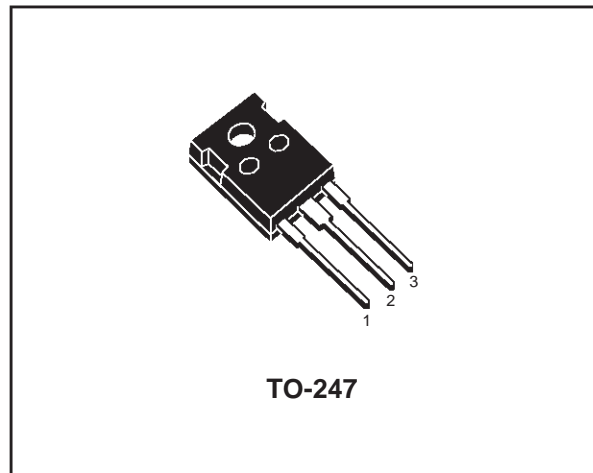

ABSOLUTE MAXIMUM RATINGS

Symbol	Parameter	Value	Unit
V _{DS}	Drain-source Voltage (V _{GS} = 0)	1000	V
V _{DGR}	Drain- gate Voltage (R _{GS} = 20 kΩ)	1000	V
V _{GS}	Gate-source Voltage	± 30	V
I _D	Drain Current (continuous) at T _c = 25 °C	5.4	A
I _D	Drain Current (continuous) at T _c = 100 °C	3.4	A
I _{DM} (•)	Drain Current (pulsed)	21	A
P _{tot}	Total Dissipation at T _c = 25 °C	160	W
	Derating Factor	1.28	W/°C
dv/dt(1)	Peak Diode Recovery voltage slope	4	V/ns
T _{stg}	Storage Temperature	-65 to 150	°C
T _j	Max. Operating Junction Temperature	150	°C

(•) Pulse width limited by safe operating area

(1) I_{SD} ≤ 5.4 A, di/dt ≤ 200 A/μs, V_{DD} ≤ V_{(BR)DSS}, T_j ≤ T_{JMAX}

STW6NB100

THERMAL DATA

$R_{thj-case}$	Thermal Resistance Junction-case	Max	0.78	$^{\circ}C/W$
$R_{thj-amb}$	Thermal Resistance Junction-ambient	Max	62.5	$^{\circ}C/W$
$R_{thc-sink}$	Thermal Resistance Case-sink	Typ	0.5	$^{\circ}C/W$
T_I	Maximum Lead Temperature For Soldering Purpose		300	$^{\circ}C$

AVALANCHE CHARACTERISTICS

Symbol	Parameter	Max Value	Unit
I_{AR}	Avalanche Current, Repetitive or Not-Repetitive (pulse width limited by T_j max)	5.4	A
E_{AS}	Single Pulse Avalanche Energy (starting $T_j = 25^{\circ}C$, $I_D = I_{AR}$, $V_{DD} = 50$ V)	373	mJ

ELECTRICAL CHARACTERISTICS ($T_{case} = 25^{\circ}C$ unless otherwise specified)

OFF

Symbol	Parameter	Test Conditions	Min.	Typ.	Max.	Unit
$V_{(BR)DSS}$	Drain-source Breakdown Voltage	$I_D = 250 \mu A$ $V_{GS} = 0$	1000			V
I_{DSS}	Zero Gate Voltage Drain Current ($V_{GS} = 0$)	$V_{DS} = \text{Max Rating}$ $V_{DS} = \text{Max Rating}$ $T_c = 125^{\circ}C$			1 50	μA μA
I_{GSS}	Gate-body Leakage Current ($V_{DS} = 0$)	$V_{GS} = \pm 30$ V			± 100	nA

ON (*)

Symbol	Parameter	Test Conditions	Min.	Typ.	Max.	Unit
$V_{GS(th)}$	Gate Threshold Voltage	$V_{DS} = V_{GS}$ $I_D = 250 \mu A$	3	4	5	V
$R_{DS(on)}$	Static Drain-source On Resistance	$V_{GS} = 10$ V $I_D = 2.7$ A		2.5	2.8	Ω
$I_{D(on)}$	On State Drain Current	$V_{DS} > I_{D(on)} \times R_{DS(on)max}$ $V_{GS} = 10$ V	6			A

DYNAMIC

Symbol	Parameter	Test Conditions	Min.	Typ.	Max.	Unit
g_{fs} (*)	Forward Transconductance	$V_{DS} > I_{D(on)} \times R_{DS(on)max}$ $I_D = 2.7$ A	1.5	3		S
C_{iss}	Input Capacitance	$V_{DS} = 25$ V $f = 1$ MHz $V_{GS} = 0$		1500		pF
C_{oss}	Output Capacitance			180		pF
C_{rss}	Reverse Transfer Capacitance			17		pF

ELECTRICAL CHARACTERISTICS (continued)

SWITCHING ON

Symbol	Parameter	Test Conditions	Min.	Typ.	Max.	Unit
$t_{d(on)}$	Turn-on Time	$V_{DD} = 500\text{ V}$ $I_D = 2.5\text{ A}$ $R_G = 4.7\ \Omega$ $V_{GS} = 10\text{ V}$ (see test circuit, figure 3)		24		ns
t_r	Rise Time			11		ns
Q_g	Total Gate Charge	$V_{DD} = 800\text{ V}$ $I_D = 5\text{ A}$ $V_{GS} = 10\text{ V}$		39	55	nC
Q_{gs}	Gate-Source Charge			10		nC
Q_{gd}	Gate-Drain Charge			19		nC

SWITCHING OFF

Symbol	Parameter	Test Conditions	Min.	Typ.	Max.	Unit
$t_{r(Voff)}$	Off-voltage Rise Time	$V_{DD} = 800\text{ V}$ $I_D = 5\text{ A}$ $R_G = 4.7\ \Omega$ $V_{GS} = 10\text{ V}$ (see test circuit, figure 5)		40		ns
t_f	Fall Time			22		ns
t_c	Cross-over Time			26		ns

SOURCE DRAIN DIODE

Symbol	Parameter	Test Conditions	Min.	Typ.	Max.	Unit
I_{SD}	Source-drain Current				5.4	A
$I_{SDM}(\bullet)$	Source-drain Current (pulsed)				21	A
$V_{SD}(\ast)$	Forward On Voltage	$I_{SD} = 5.4\text{ A}$ $V_{GS} = 0$			1.6	V
t_{rr}	Reverse Recovery Time	$I_{SD} = 5\text{ A}$ $di/dt = 100\text{ A}/\mu\text{s}$ $V_{DD} = 100\text{ V}$ $T_j = 150\text{ }^\circ\text{C}$ (see test circuit, figure 5)		780		ns
Q_{rr}	Reverse Recovery Charge			5.5		μC
I_{RRM}	Reverse Recovery Current			14		A

(*) Pulsed: Pulse duration = 300 μs , duty cycle 1.5 %

(•) Pulse width limited by safe operating area

Safe Operating Area

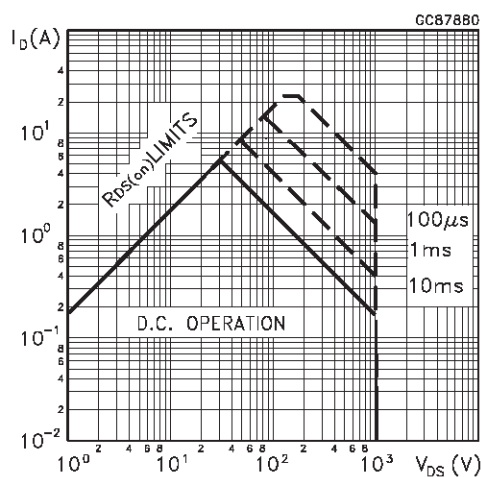

Thermal Impedance

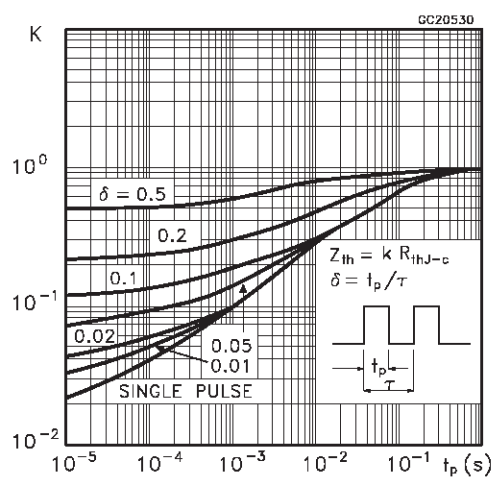

Output Characteristics

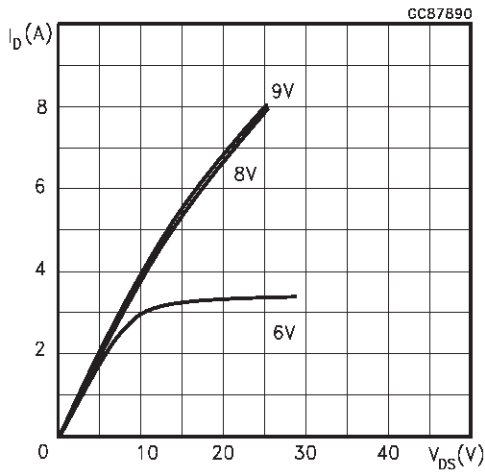

Transfer Characteristics

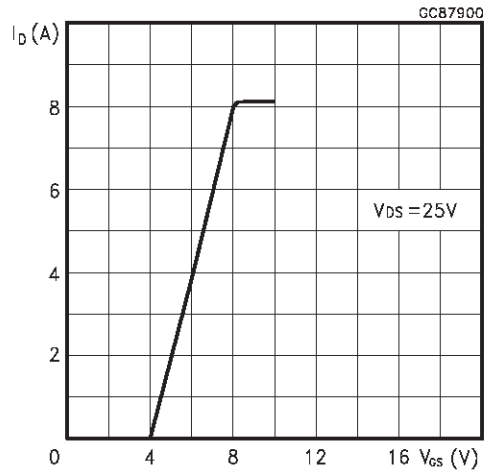

Transconductance

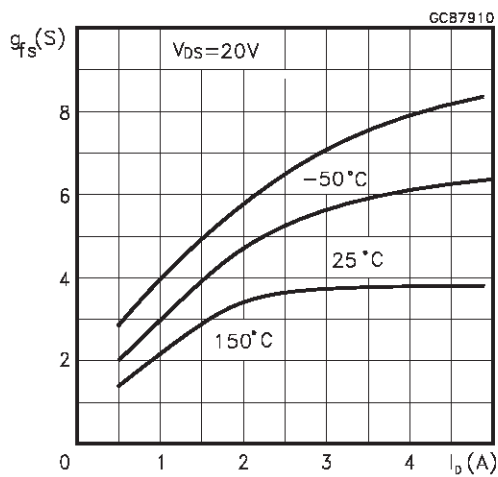

Static Drain-source On Resistance

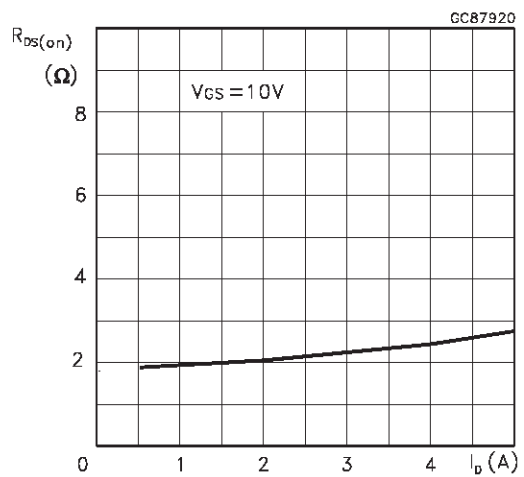

Gate Charge vs Gate-source Voltage

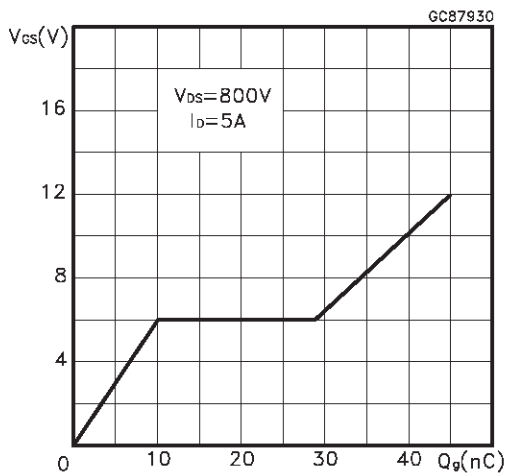

Capacitance Variations

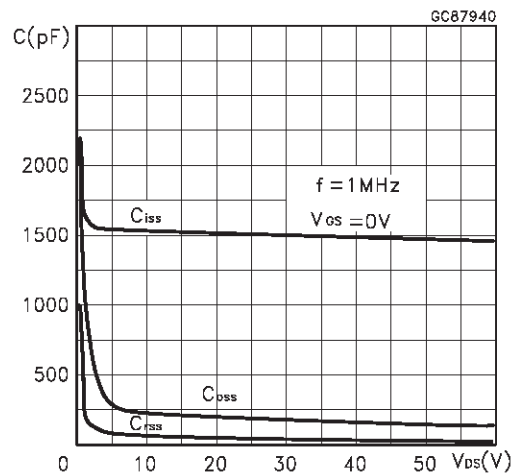

Normalized Gate Threshold Voltage vs Temperature

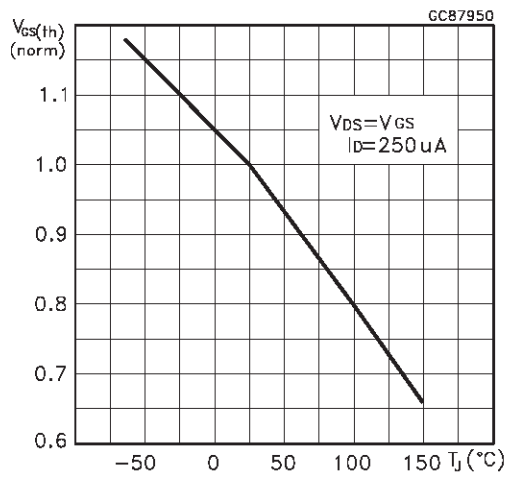

Normalized On Resistance vs Temperature

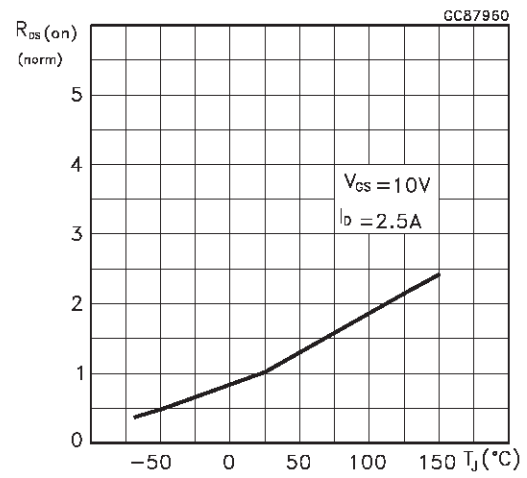

Source-drain Diode Forward Characteristics

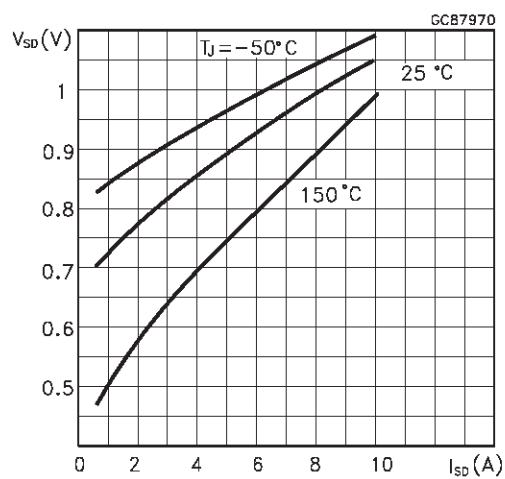

Fig. 1: Unclamped Inductive Load Test Circuit



Fig. 2: Unclamped Inductive Waveform



Fig. 3: Switching Times Test Circuits For Resistive Load



Fig. 4: Gate Charge test Circuit

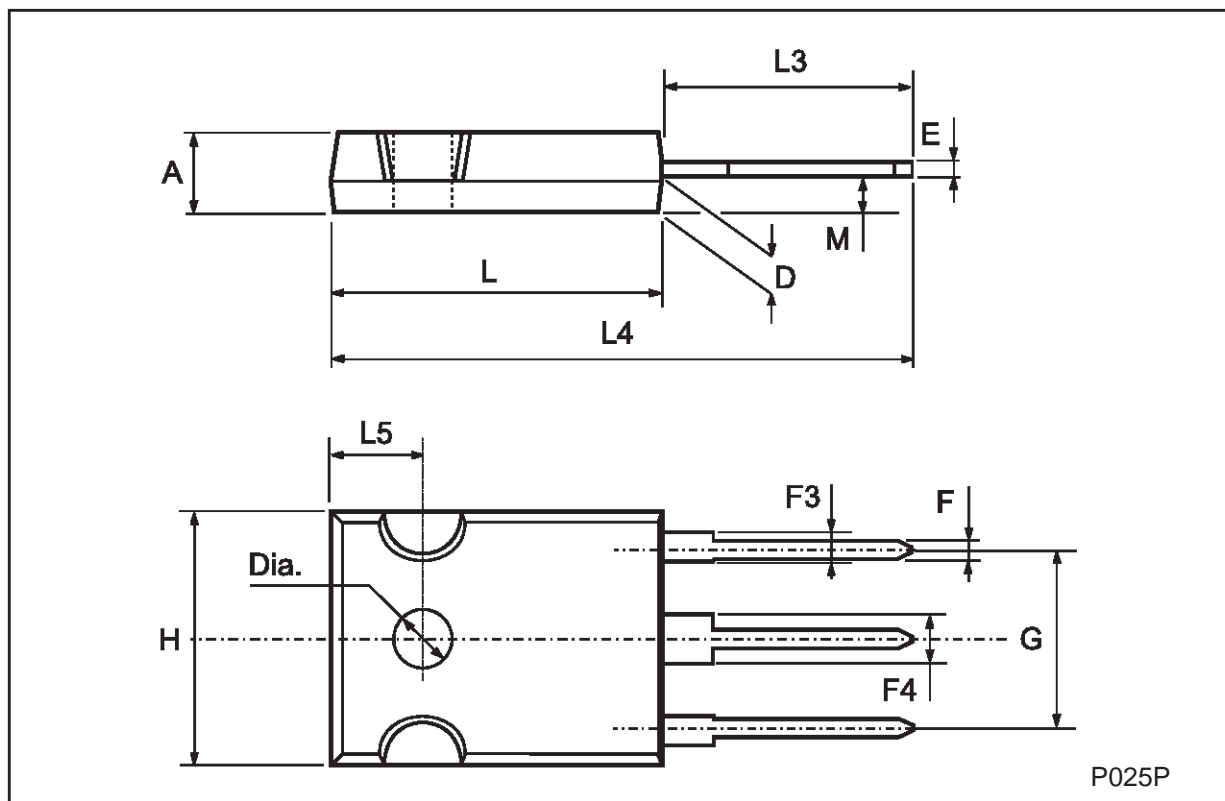

Fig. 5: Test Circuit For Inductive Load Switching And Diode Recovery Times



TO-247 MECHANICAL DATA

DIM.	mm			inch		
	MIN.	TYP.	MAX.	MIN.	TYP.	MAX.
A	4.7		5.3	0.185		0.209
D	2.2		2.6	0.087		0.102
E	0.4		0.8	0.016		0.031
F	1		1.4	0.039		0.055
F3	2		2.4	0.079		0.094
F4	3		3.4	0.118		0.134
G		10.9			0.429	
H	15.3		15.9	0.602		0.626
L	19.7		20.3	0.776		0.779
L3	14.2		14.8	0.559		0.582
L4		34.6			1.362	
L5		5.5			0.217	
M	2		3	0.079		0.118



Information furnished is believed to be accurate and reliable. However, STMicroelectronics assumes no responsibility for the consequences of use of such information nor for any infringement of patents or other rights of third parties which may result from its use. No license is granted by implication or otherwise under any patent or patent rights of STMicroelectronics. Specification mentioned in this publication are subject to change without notice. This publication supersedes and replaces all information previously supplied. STMicroelectronics products are not authorized for use as critical components in life support devices or systems without express written approval of STMicroelectronics.

The ST logo is a trademark of STMicroelectronics

© 1999 STMicroelectronics – Printed in Italy – All Rights Reserved
STMicroelectronics GROUP OF COMPANIES

Australia - Brazil - China - Finland - France - Germany - Hong Kong - India - Italy - Japan - Malaysia - Malta - Morocco -
Singapore - Spain - Sweden - Switzerland - United Kingdom - U.S.A.